

Installation Instructions

Surface Fixed

Tembos
Page 1 of 3



1. Locate Tembos frame onto legs and, and bolt into place using pre drilled holes, **2 bolts per post.**(See Assembly Guide)

2. Attach Surface Fixing posts to legs(1.2) (See Ground Fix Post Installation Sheet)

3. Locate Instrument in desired location and mark holes to fix to desired surface.

4. Fix to Surface using recommended ground anchors not supplied

5. Make sure all fixings are covered and secure using cover caps provided



Weight of heaviest part 52kg (Tembo Frame)

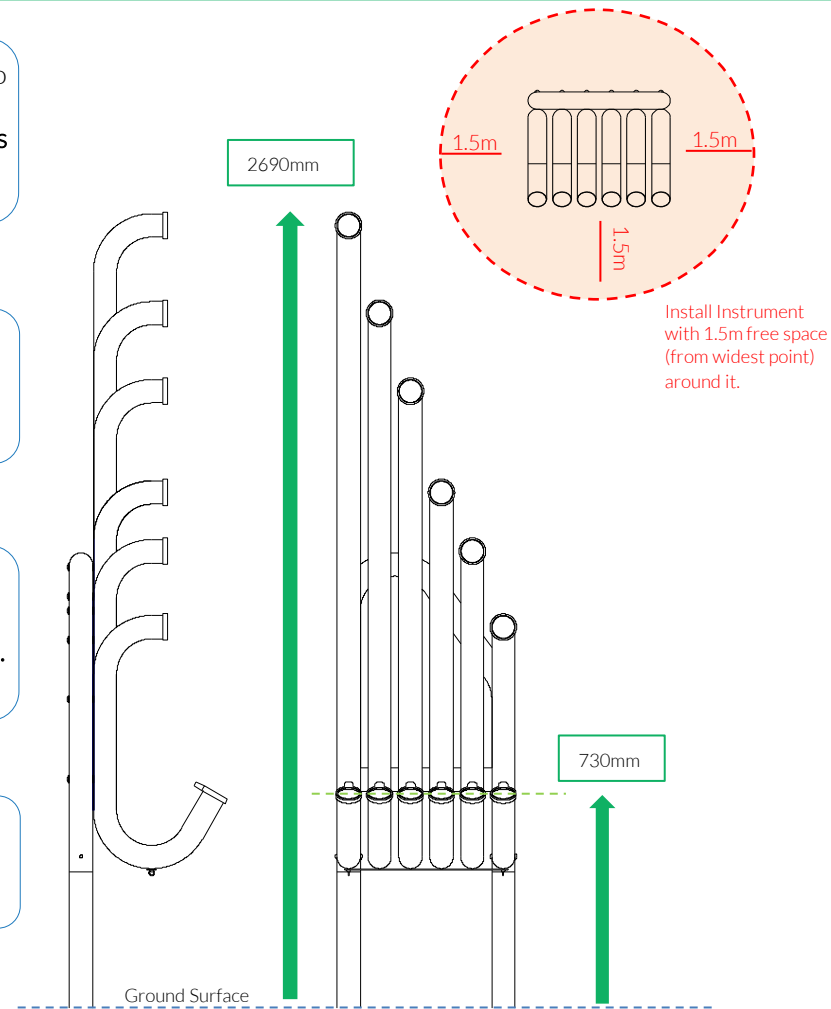

CAUTION: Tembos surface can get hot in direct sunlight, if possible install in shaded areas.

Components:



x12

M10x100 Security Screw



x24

M10 Flanged Slide Bearing



x2

M6 Eye Bolt

Metric Conversion:
730mm/ 28 47/64"
1.5m/ 59"
2690mm/ 106"



Pair Neoprene Paddles X1

Surface Fix Components:



x4

M10x70 Security Screw



x4

M10 Barrel Nut



x8

2 Part Cover Cap



Spares available from percussionplay.com or from your local distributor

70 Kg

Tools:

Pin Hex Driver Bit x1
TX 45 Driver Bit x2

Surface Fixed
Tembos
Page 2 of 3



Instrument Components:





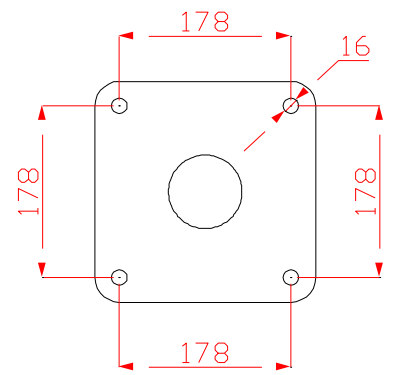
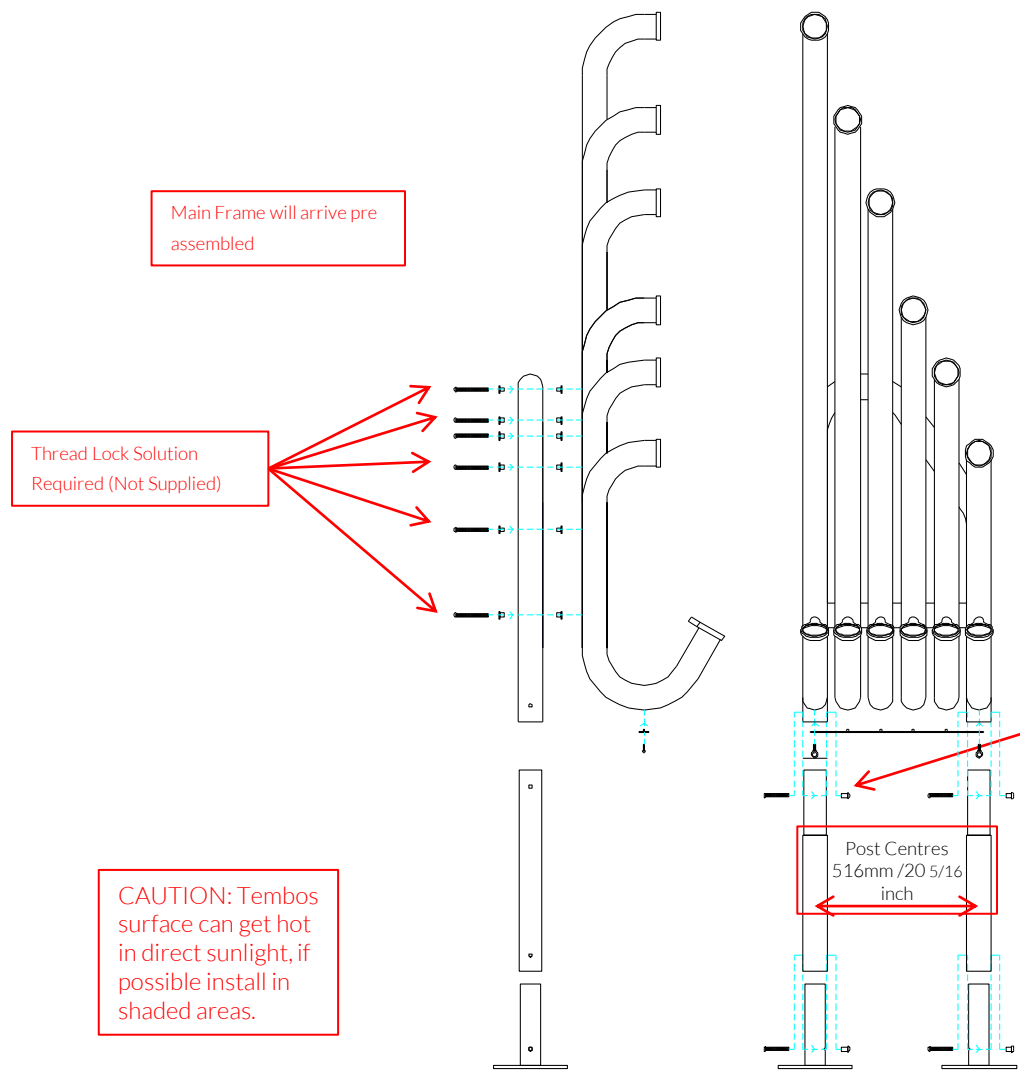

-  x12
M10x100 Security Screw
-  x24
M10 Flanged Slide Bearing
-  x2
M6 Eye Bolt

Thread Lock Solution Required (Not Supplied)



Thread Lock Solution Required (Not Supplied)



COMPONENTS LIST:

-  M6 Eye Bolt X2
-  M10x70 Pin torx X4
-  M10 Barrel Nut Pin torx X4
-  M10x100 Pin torx X12
-  M10 Black Slide Plastic Bearing X12
-  SS Brace Bar X1



Pair Neoprene Paddles X1

Ground Fix Components:

-  x4
M10x70 Security Screw
-  x4
M10 Barrel Nut
-  x8
2 Part Cover Cap



Spares available from percussionplay.com or from your local distributor

70 Kg

Tools:

 x2
TX 45 Driver Bit

Surface Fixed

Tembos
Page 3 of 3



Components:

 x4

M10 Barrel Nut

 x4

M10x70 Security Screw

 x8

2 Part Cover Cap

Thread Lock Solution
Required (Not Supplied)

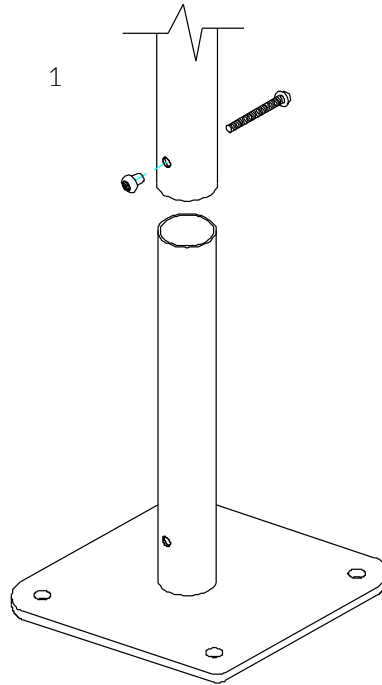

Locate the Surface fix Plate into the leg of the instrument.

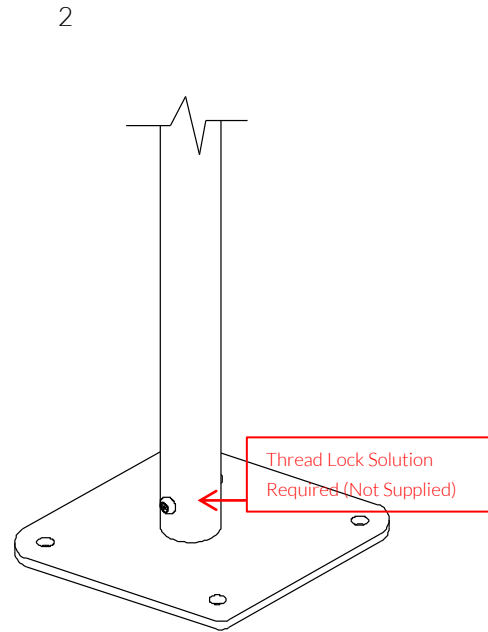

Fix instrument to Surface fix plate using M10 bolt and Barrel Nut and use **thread locking solution** to prevent fixings working loose.

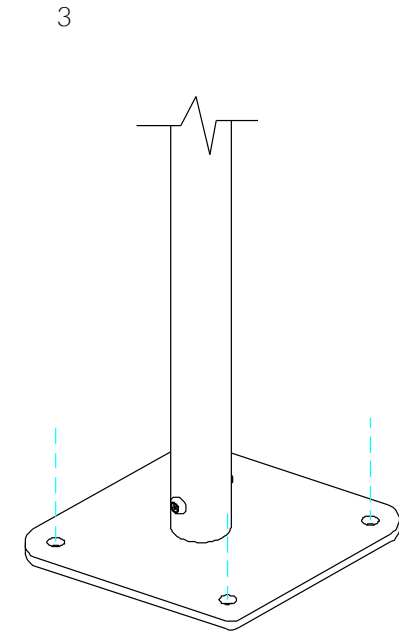

Fix Surface Plate to the ground surface **Ground Anchors Not provided** cover fixings with caps provided

Repeat Parts 1-3 for both legs



MADE IN
BRITAIN

BSEN 1176

