

# Installation Instructions

## Surface Fixed

Rainbow Bongos  
1 of 2



### Instrument Components:



x6

M10x50 Security Screw



x6

M10x50x3 Square washer



x4

PU 200 Mount



x2

PU 250 Mount

Metric Conversion:  
250mm/ 10"  
850mm/ 33"  
1.5m/ 59"

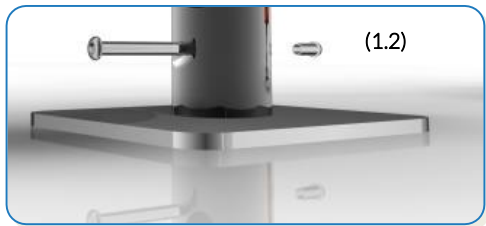
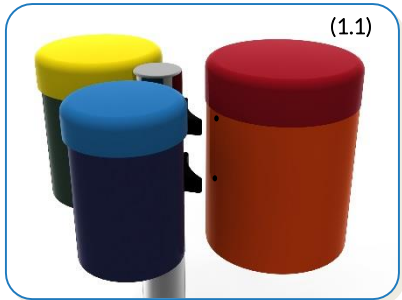

Weight of heaviest part 7 kg (bongos)

1. Attach the steel leg to each of the congas with the M10x50 security screws, square washers and PU mounts. (1.1) (See Assembly Guide)

2. Attach Surface Fixing posts to legs (1.2) (See Ground Fix Post Installation Sheet)

3. Locate Plate in desired location and mark holes to fix to desired surface.

4. Fix to Surface using recommended ground anchors not supplied

5. Make sure all fixings are covered and secure using cover caps provided

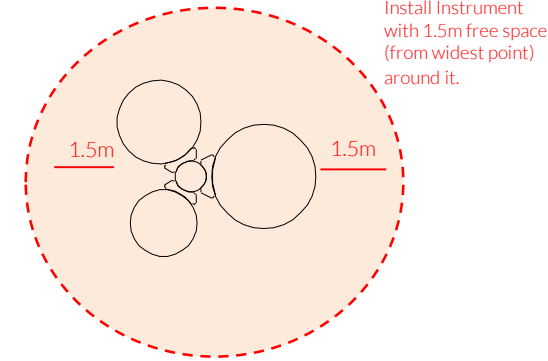

850mm  
from Plate

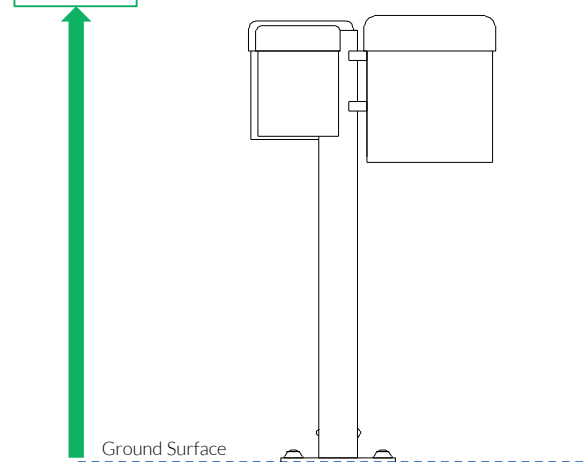

Surface Fix Components:



x1



x1



x4

Ground Anchors not supplied

Spares available from [percussionplay.com](http://percussionplay.com) or from your local distributor

15 Kg





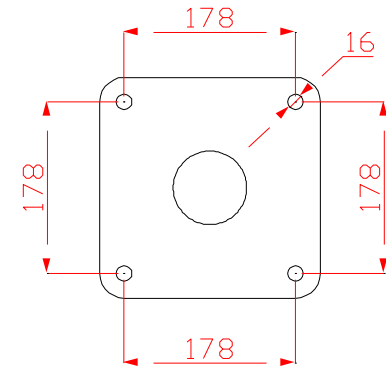

Tools:



x2  
TX 45 Driver Bit



COMPONENTS LIST:

-  M10x50 Pin torx X6
-  M10x50x3 square washer X6
-  HDPE MOUNT 200 X4
-  HDPE MOUNT 250 X2
-  2 Part Cover Cap X4
-  M10x70 Pin torx X1
-  M10 Barrel Nut Pin torx X1

Thread Lock Solution  
Required (Not Supplied)

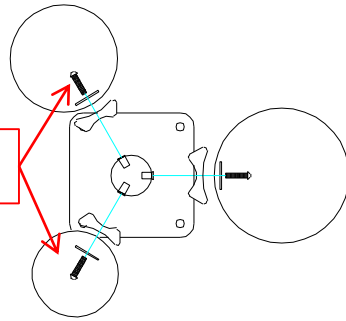





## Surface Fixed

Rainbow Bongos  
2 of 2



### Instrument Components:

-  x6  
M10x50 Security Screw
-  x6  
M10x50x3 Square washer
-  x4  
PU 200 Mount
-  x2

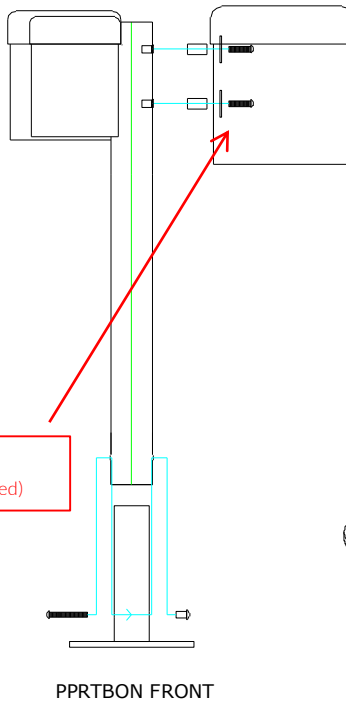

Thread Lock Solution  
Required (Not Supplied)

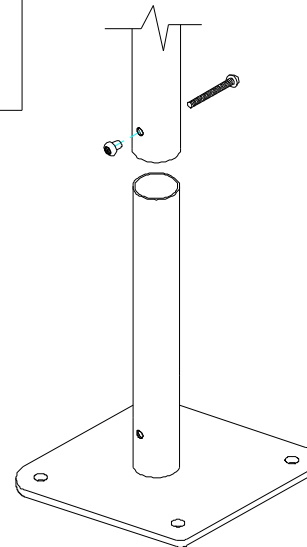

Locate the Surface fix Plate into the leg of the instrument.

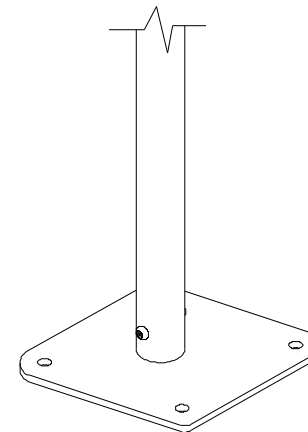

Fix instrument to Surface fix plate using M10 bolt and Barrel Nut and use **thread locking solution** to prevent fixings working loose.

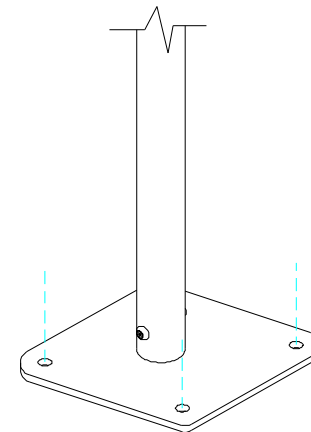



Fix Surface Plate to the ground surface **Ground Anchors Not provided** cover fixings with caps provided



Played with hands

Surface Fix Components:

-  x1
-  x1
-  x4

Ground Anchors not supplied

Spares available from [percussionplay.com](http://percussionplay.com) or from your local distributor

15 Kg