

# Installation Instructions



1. Attach Petal Drum section to frame with security screws provided. **(1.1)** (See Assembly Guide)

2. Attach Ground Fixing studs holes in base of centre post **(1.2)** (See Ground Fix Post Installation Sheet)

3. Excavate 1 hole for the Steel legs **250mm diameter by 450mm deep** in desired location upon decision from customer.

4. Locate (lower) leg into hole, making sure it is vertical and level prior to concreting in place.

5. Once happy with location of the Instrument, **fill** holes using rapid hardening **concrete**. Be sure to compact concrete around legs and leave to dry according to manufacturers guidelines.

6. Attach the 1 of the beaters to each of the saddle strap on the hex frame. **(1.3)**

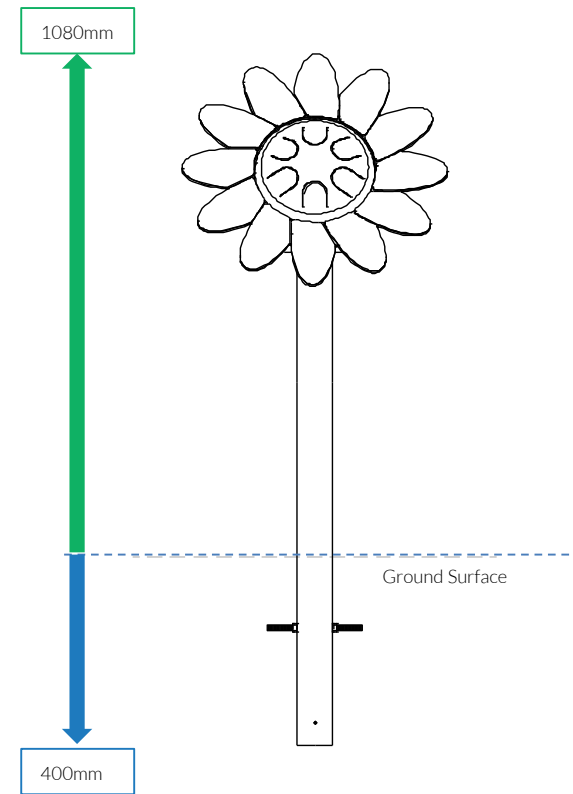
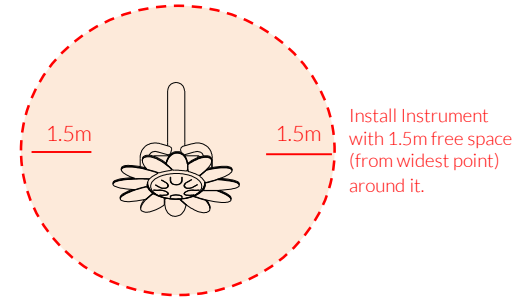

Weight of heaviest part 7.5kg



Ground Fixed  
Petal Drum  
Page 1 of 3



Instrument Components:

 x4  
M6x20 Security Screw

 x2  
M6 Saddle Strap

Metric Conversion:  
250mm/ 10"  
400mm/ 16"  
450mm/ 18"  
1080mm/ 42.5"  
1.5m/ 59"



Pair Small Black Beaters X1

Ground Fix Components:

 x2  
M10x200 Bolt

 x4  
M10 Nut

Tools:  
 x1  
 TX 30 Driver Bit





Install 3X PU Inserts into each arm before installing petal section

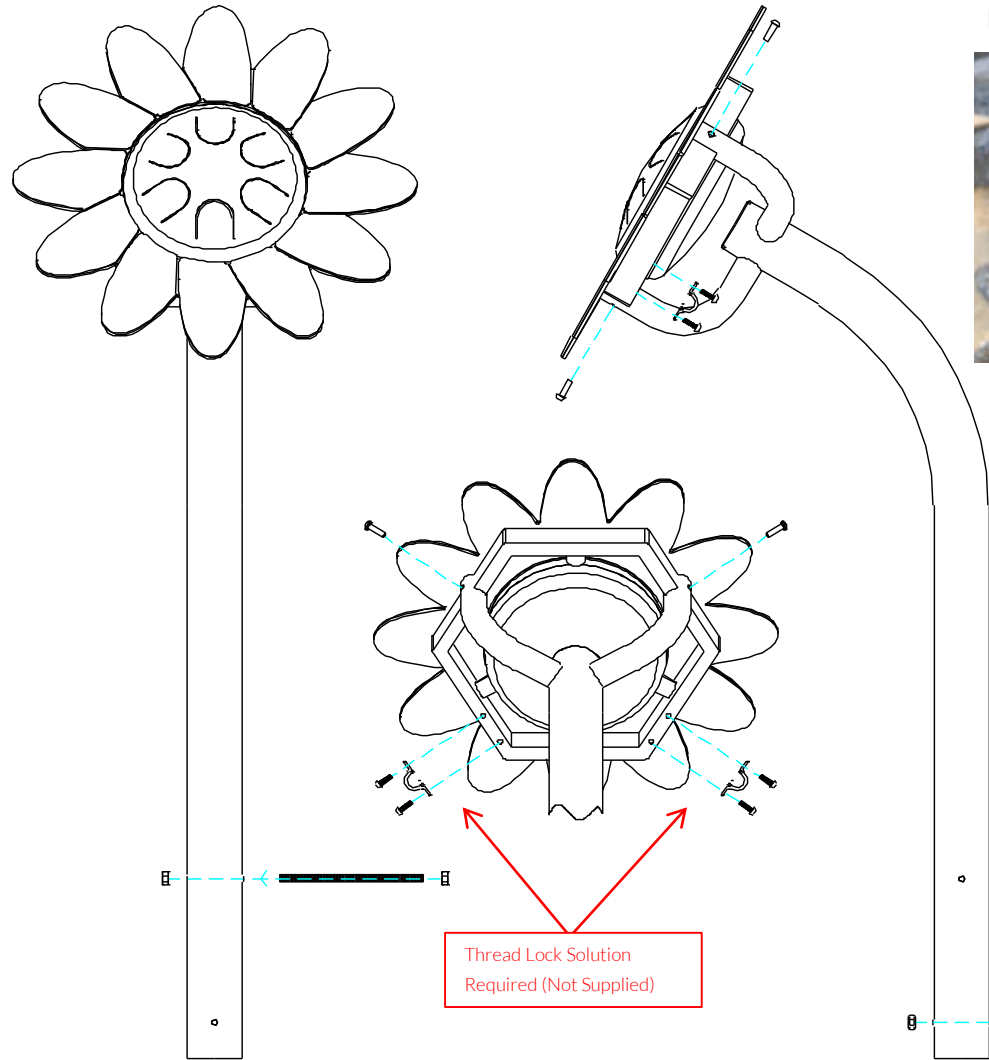

Ground Fixed  
 Petal Drum  
 Page 2 of 3



**COMPONENTS LIST:**

-  M8x25 Pin torx X3
-  M10 Nut X4
-  M10x200 Threaded Bar X2
-  Saddle Strap X2
-  M6x20 Pin torx X4

**Instrument Components:**

-  x4  
M6x20 Security Screw
-  x2  
M6 Saddle Strap

Thread Lock Solution  
 Required (Not Supplied)

Thread Lock Solution  
 Required (Not Supplied)



Ground Fix  
 Components:

-  x2  
M10x200 Bolt
-  x4  
M10 Nut

Spares available from  
[percussionplay.com](http://percussionplay.com) or from your  
 local distributor

12.5 Kg

Ground Fixed  
Petal Drum  
Page 3 of 3



Components:



x2

M10x200 Bolt



x4

M10 Nut

Metric Conversion:

- 50mm/ 2"
- 250mm/ 10"
- 350mm/ 14"
- 400mm/ 16"
- 450mm/ 18"

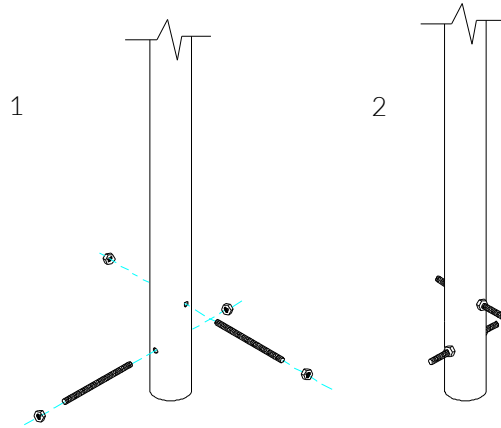

Fix M10x 200 Threaded bar in place using M10 Nuts

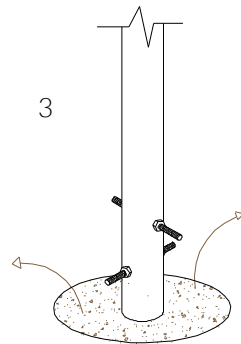

Excavate 1 holes with a 250mm diameter tapering down to 350mm diameter and 450mm depth

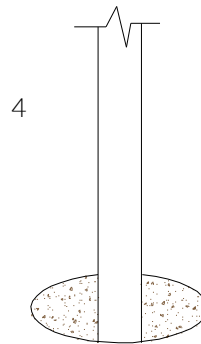

Compact base of hole with 50mm of aggregate. Lower ground Fix post into hole (check instrument straight and level before filling with concrete)

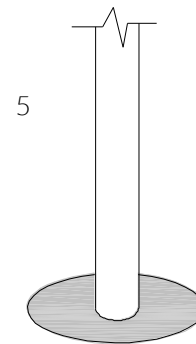

Fix hole with fast drying concrete to manufacturers specifications.

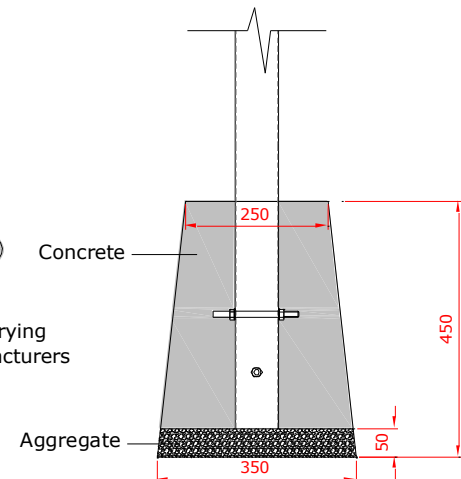

400mm min depth



MADE IN BRITAIN

BSEN 1176