

Installation Instructions Flat Pack

Surface Fixed

Marimba
Page 1 of 2

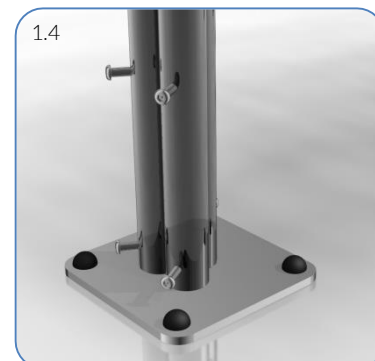
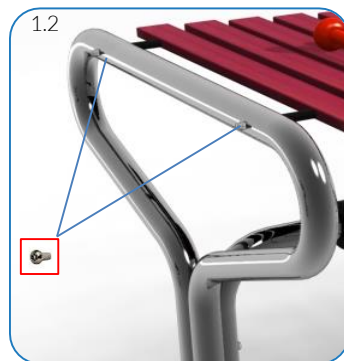

1.1

1.2

1.4

1.3

1.5

1. Assemble frame and notes as shown in images 1.2, 1.3 and 1.4 (see Assembly Guide)

2. Attach Surface Fixing Plates to base of each leg using fixings provided (See Surface Fix Post Installation Sheet)

3. Locate Instrument in desired location and mark holes to fix to desired surface.

4. Fix to Surface using recommended ground anchors not supplied

5. Make sure all fixings are covered and secure using cover caps provided

6. Beaters can be fixed to frame with fixings provided

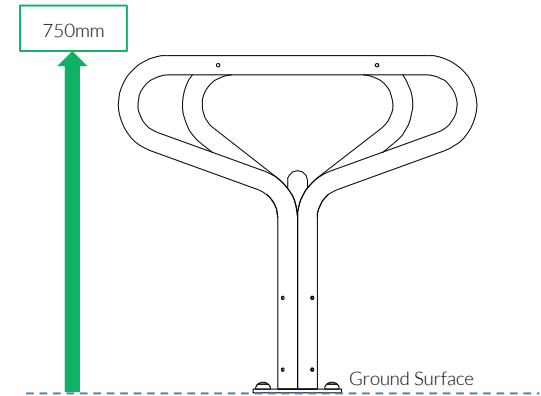
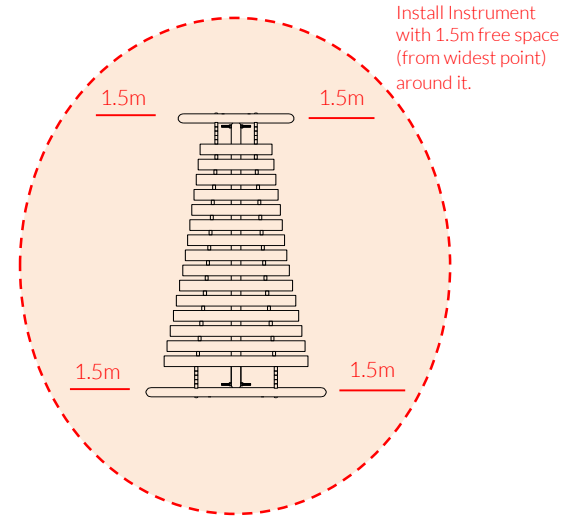

Metric
Conversion:
250mm/ 10"
300mm/ 12"
400mm/ 16"
750mm/ 30"
1.5m/ 59"

Weight of heaviest part 15kg (Notes)

Instrument Components:

-  x4
-  x2
-  x4
-  x4
-  x4



Surface Fix Components :



Ground Anchors not supplied

Spares available from percussionplay.com or from your local distributor

42 Kg

Tools:

 x1
 x1

TX 40 Driver Bit TX 30 Driver Bit

Surface Fixed
Marimba
Page 2 of 2







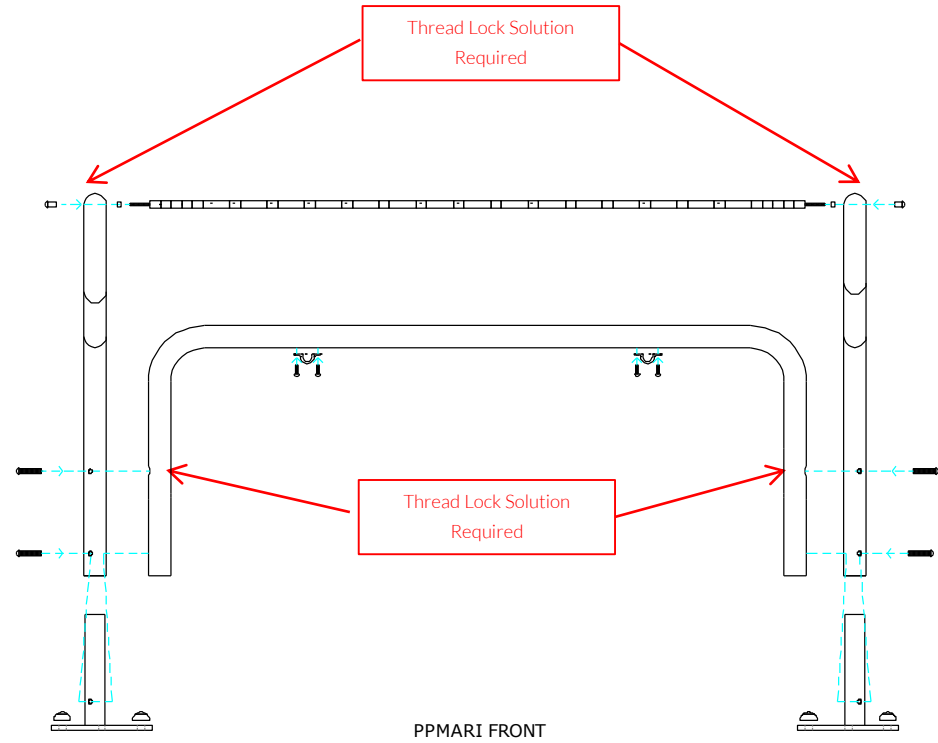
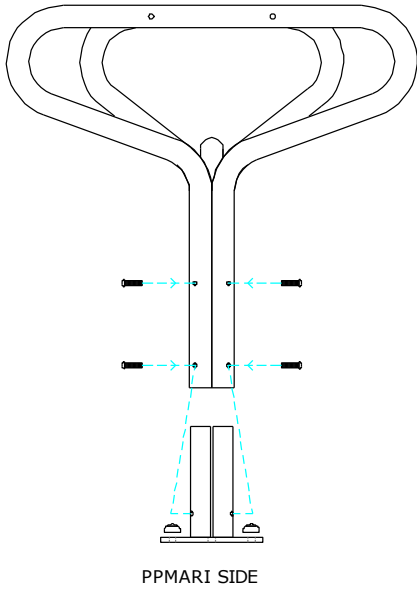

Instrument Components:

-  x4
-  x2
-  x4
-  x4
-  x4

Thread Lock Solution Required



- COMPONENTS LIST:**
-  M8x60 Pin torx X8
 -  M8 Barrel Nut Pin torx X4
 -  M8 Square nut X4
 -  Saddle Strap X2
 -  M6x20 Pin torx X4
 -  2 Part black cap X8

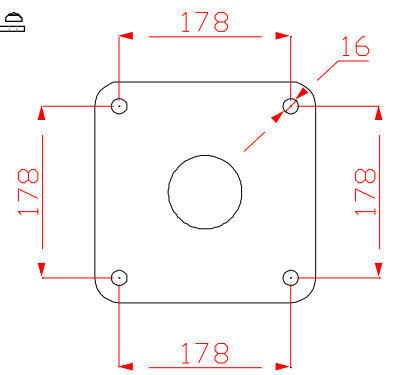

Pair Large Red Beaters X2

Surface Fix Components:

-  x4
-  x8

Ground Anchors not supplied

Spares available from percussionplay.com or from your local distributor

42 Kg