

Installation Instructions

Ground Fixed Flat Pack Harmony

Page 1 of 3

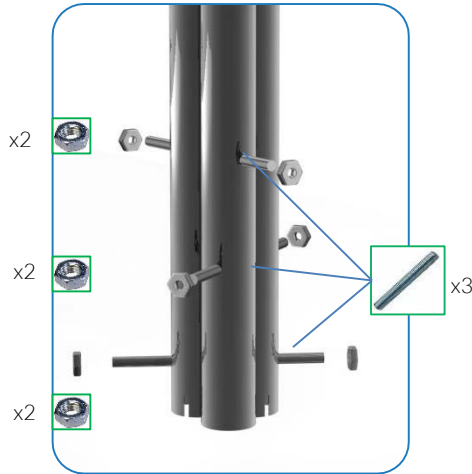

Weight of heaviest part **16kg** (Harmony Frame)

1. Unpack frame 3no.
2. Lay packaging out on floor or assemble on non-abrasive surface to prevent marking of polished stainless steel.
3. Align holes on legs (opposite end to polished domes) and secure in place using 3no. M10 x 200mm threaded bar and 6no. M10 nuts provided
Tools required 2no. 17mm metric spanner/wrench ($1\frac{11}{16}$ inch or alternatively using adjustable wrench)

4. Invert assembled frame so domed ends face upwards.

5. Insert M8x60mm Security screws into pre drilled holes in frame using TX40 bit.

6. Attach Notes to Harmony Frame. (See Assembly Guide Sheet)

3. Excavate 1 hole for the Steel leg **250mm diameter by minimum 400mm deep**, in desired location upon decision from customer.

8. Locate (lower) legs into hole making sure they are vertical and level prior to concreting in place.

5. Once happy with location of the Instrument, **fill hole using rapid hardening concrete**. Be sure to compact concrete around legs and leave to dry according to manufactures guidelines.

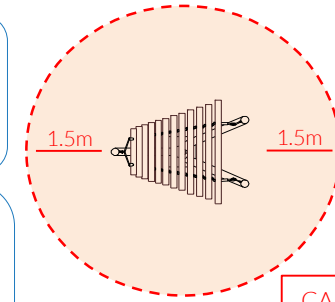

Install Instrument with 1.5m free space (from widest point) around it.

CAUTION: Harmony surface can get hot in direct sunlight, if possible install in shaded areas.

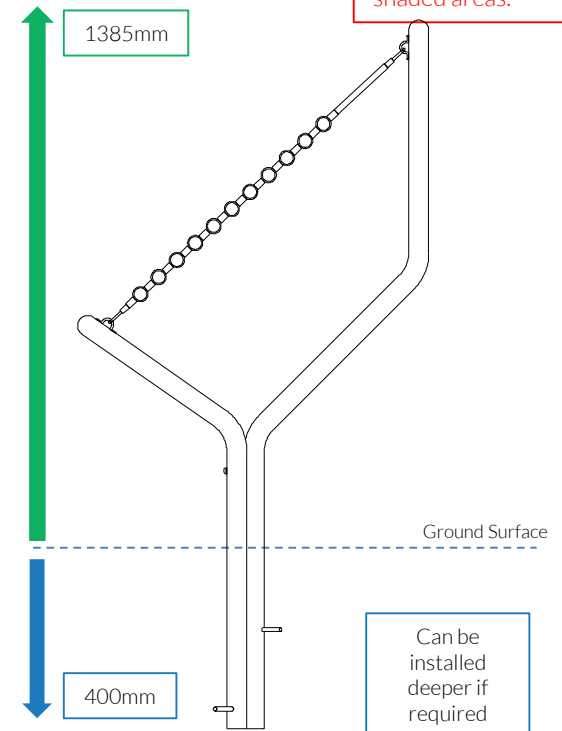

Can be installed deeper if required

Instrument Components:

- M10 Nut x6
- M6x20 Security Screw x2
- M6 Saddle Strap x3

Metric Conversion:
250mm/ 10"
400mm/ 16"
1385mm/ 55"
1.5m/ 59"

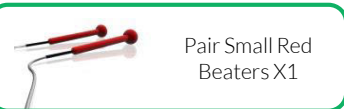



Ground Fix Components:

- M10x200 Bolt x3
- M10 Nut x6
- M8x60 Security Screw x2

Spares available from percussionplay.com or from your local distributor

20 Kg

Tools:

 x1
 x1

TX 30 Driver Bit TX 40 Driver Bit

Ground Fixed
Harmony Flat Pack
Page 2 of 3





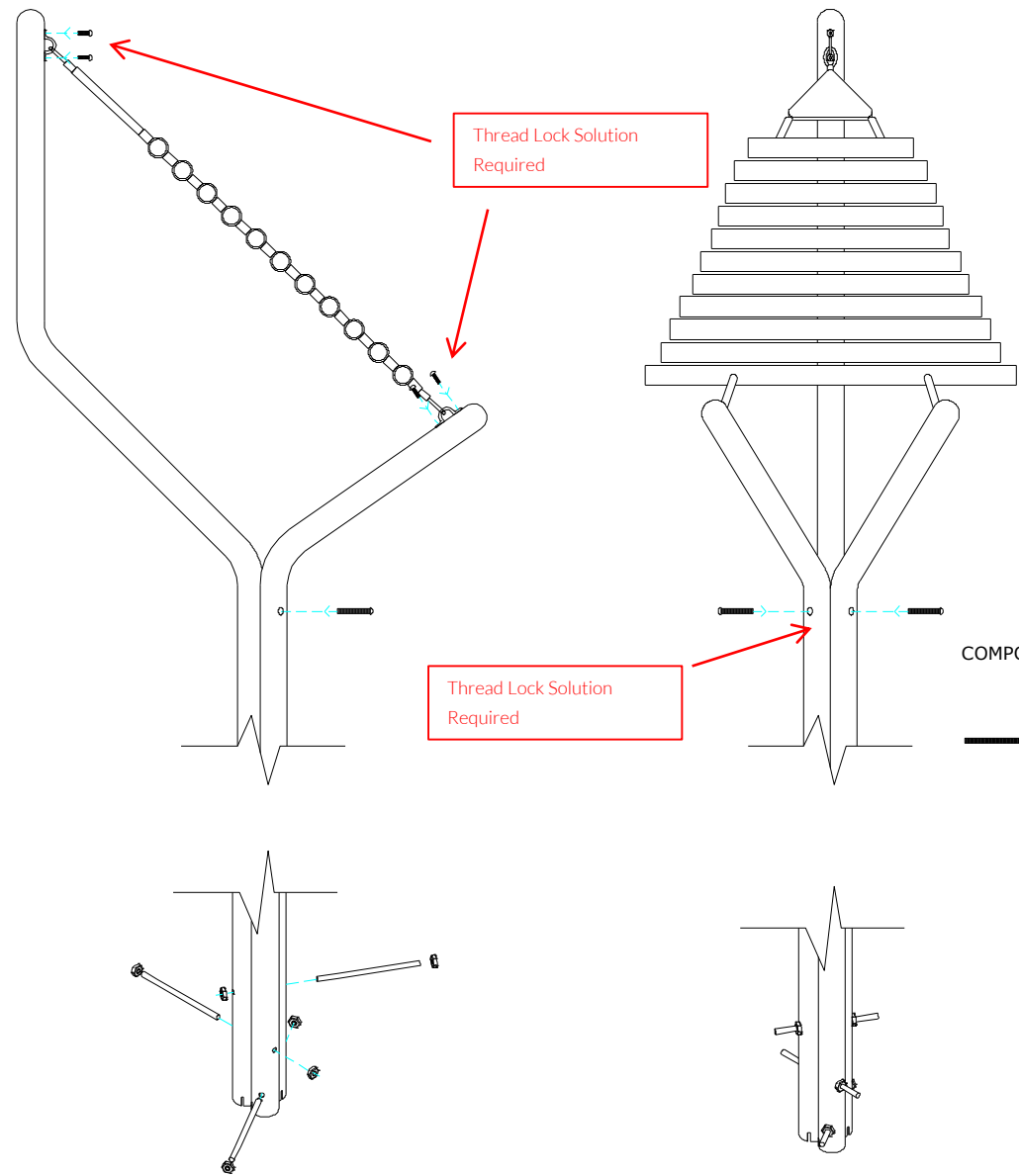

Instrument Components:

-  x6
M6x20 Security Screw
-  x3
M6 Saddle Strap

Thread Lock Solution Required





- COMPONENTS LIST:**
-  M10 Nut X6
 -  M10x200 Threaded Bar X3
 -  Saddle Strap X3
 -  M6x20 Pin torx X6
 -  M8x60 Pin torx X2

CAUTION:
Harmony surface can get hot in direct sunlight, if possible install in shaded areas.



 Pair Small Red Beaters X1

Ground Fix Components:

-  x3
M10x200 Bolt
-  x6
M10 Nut
-  x2
M8x60 Security Screw

Spares available from percussionplay.com or from your local distributor

20 Kg

Ground Fix Post Installation

Tools:



x1
TX 40 Driver Bit

Metric Conversion:
50mm/ 2"
250mm/ 10"
350mm/ 14"
400mm/ 16"
450mm/ 18"

Foundations should not present a hazard. These foundations are recommended as a guide, for more information on foundation details for various surface see Part 1 of BS EN 1176.

Ground Fixed
Harmony Flat Pack
Page 3 of 3



- Components:**
-  x3
M10x200 Threaded Bar
 -  x6
M10 BZP Nut
 -  x2
M8x60 Security Screw

Thread Lock Solution
Required

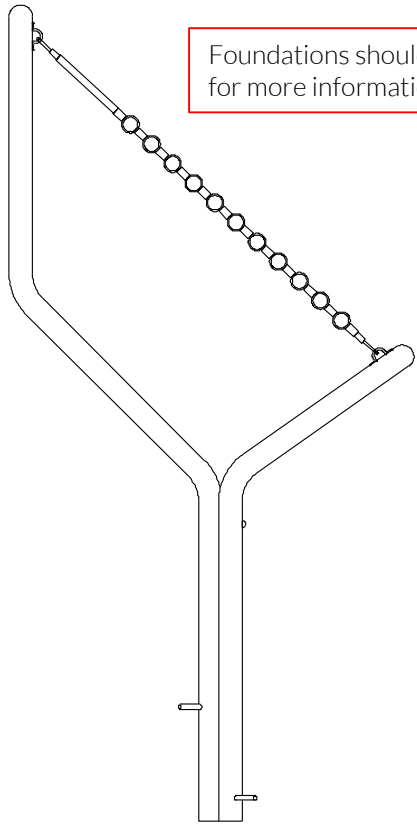

1

If Harmony needs to be positioned lower a deeper hole can be excavated.

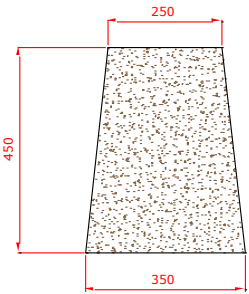

400mm min depth

Excavate a holes with a 250mm diameter tapering down to 350mm diameter and 450mm depth

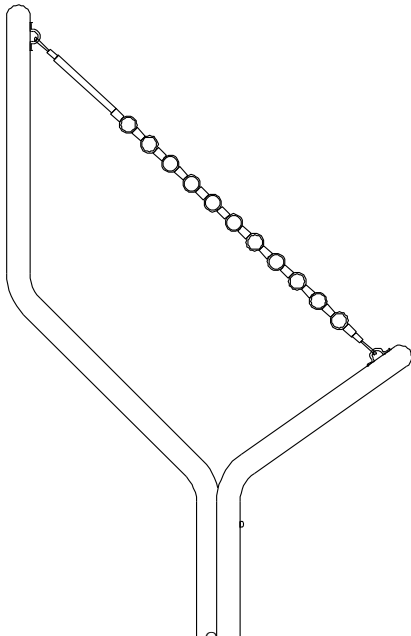

2

Compact base of hole with 50mm of aggregate. Lower ground Fix post attached to instrument into hole (check instrument straight and level before filling with concrete)

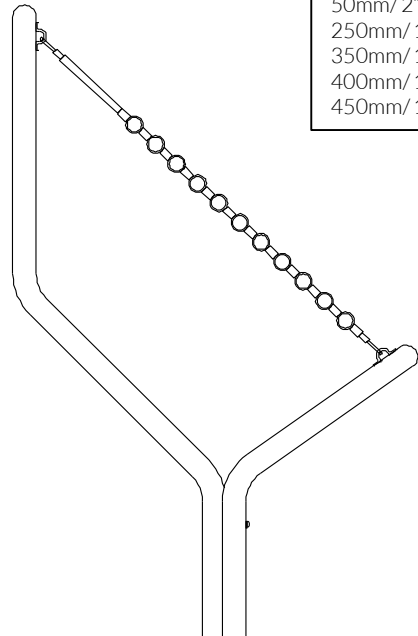
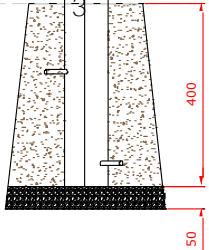

Fill hole with fast drying concrete to manufacturers specifications.