

# Installation Instructions

## Ground Fixed

Grand Marimba  
Page 1 of 3



### Instrument Components:



x4

M10x30 Security Screw



10x3/4  
Secure Screw  
X4

Metric Conversion:  
250mm/ 10"  
400mm/ 16"  
550mm/ 22"  
1.5m/ 59"

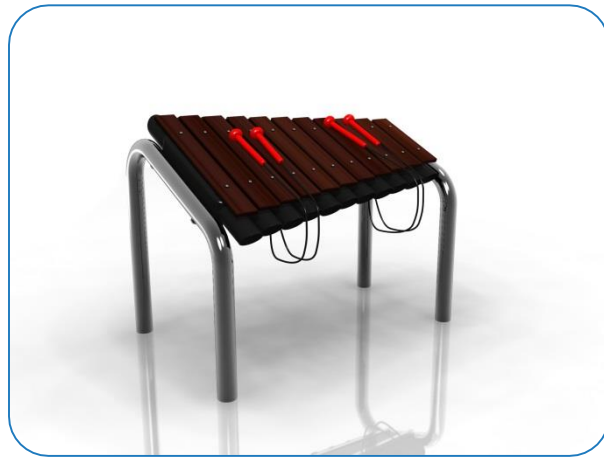

Weight of heaviest part 40kg (Grand Marimba)

1. Attach the steel legs to each end of the instrument with the M10x30 security screws. **(1.1) (See Assembly Guide)**

2. Attach Ground Fixing posts to each of the legs **(See Ground Fix Post Installation Sheet)**

3. **Excavate 4 holes** for the Steel legs **250mm diameter by 400-550mm deep** depending on Key stage, in desired location upon decision from customer.

4. Locate (lower) legs into holes making sure they are vertical and level prior to concreting in place.

5. Once happy with location of the Instrument, **fill holes using rapid hardening concrete**. Be sure to compact concrete around legs and leave to dry according to manufactures guidelines.

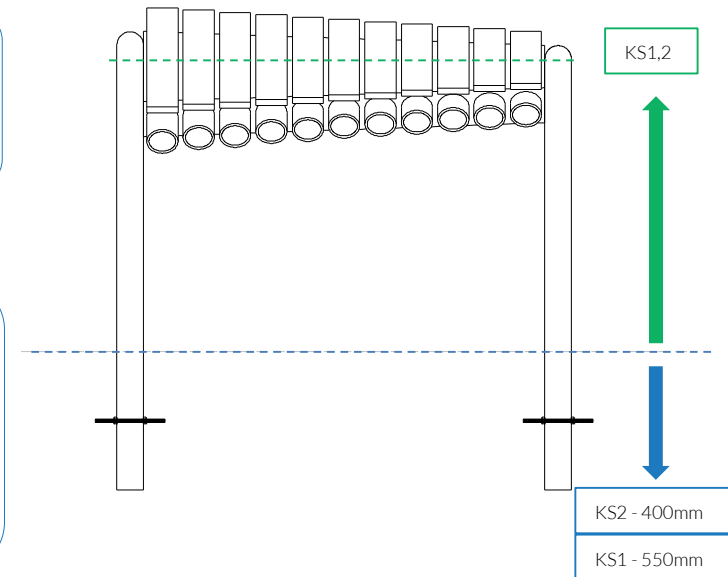
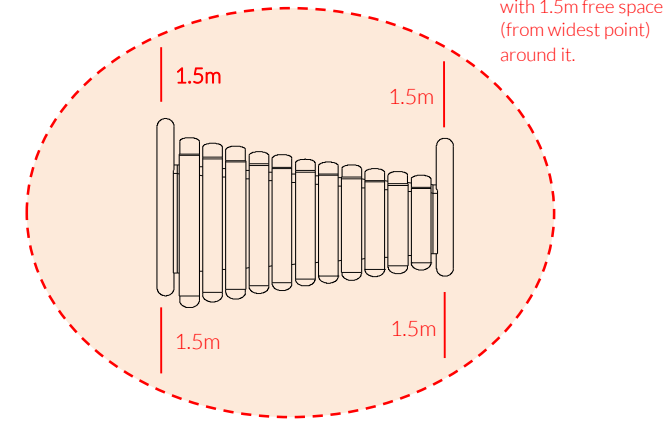



### Ground Fix Components:



Spares available from [percussionplay.com](http://percussionplay.com) or from your local distributor

48 Kg

**Tools:**

 x1  
 x1  

TX 25 Driver Bit      TX 45 Driver Bit

Thread Lock Solution  
Required (Not Supplied)

Ground Fixed  
Grand Marimba  
Page 2 of 3



Instrument Components:





 x4  

M10x30 Security Screw

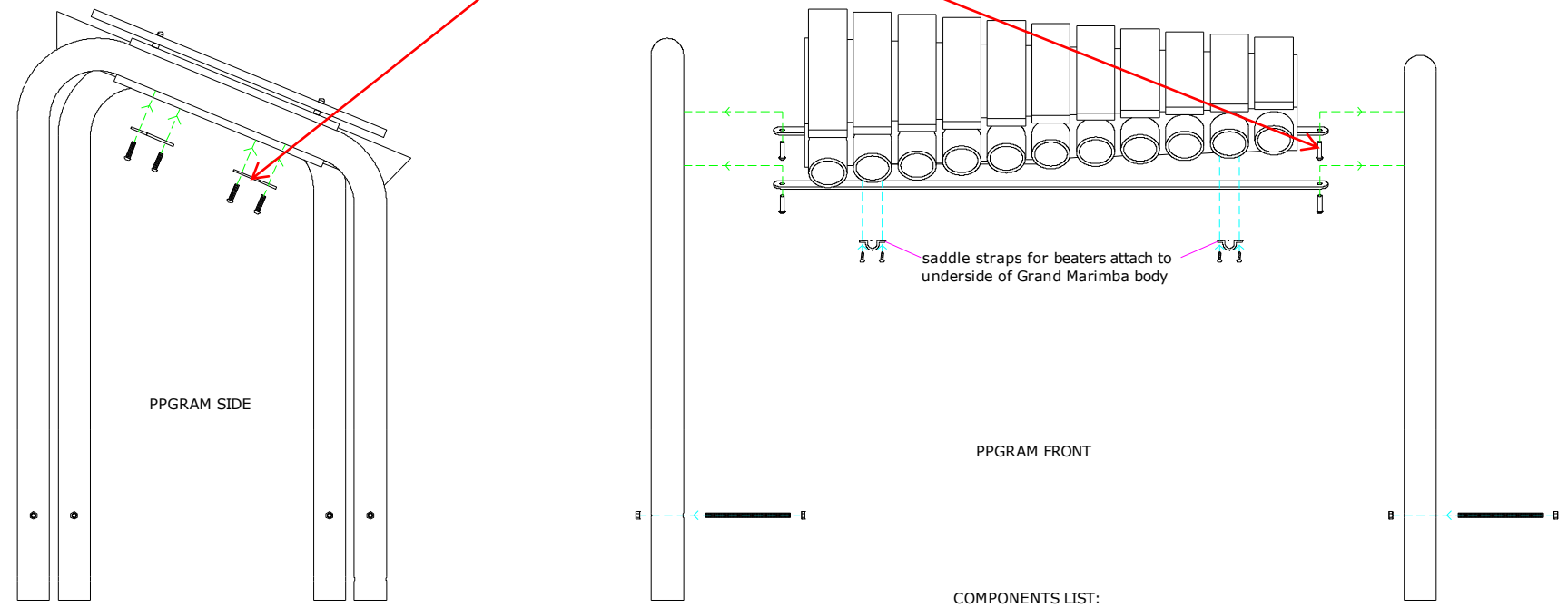
 X4  

10x3/4 Secure Screw X4



- COMPONENTS LIST:**
-  M10 Nut X8
  -  M10x200 Threaded Bar X4
  -  Saddle Strap X2
  -  10x3/4 Pin torx Screw X4
  -  M10x30 Pin torx X4

Thread Lock Solution  
Required (Not Supplied)



Pair Large Red Beaters X2

Ground Fix Components:

 x4  
 x8  

M10x200 Bolt      M10 Nut

Spares available from  
[percussionplay.com](http://percussionplay.com) or from your local distributor

48 Kg

# Ground Fix Post Installation

Tools:  
x1  
TX 45 Driver Bit

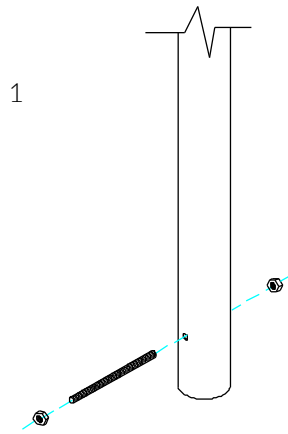

1

Insert M10x 200 Threaded bar into pre drilled holes in Ground Fixing Post

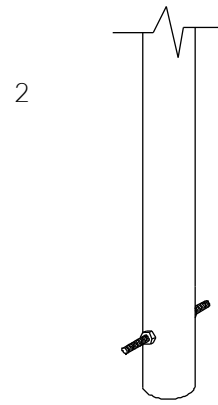

2

Fix M10x 200 Threaded bar in place using M10 Nuts

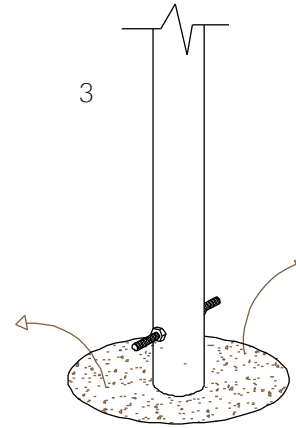

3

Excavate a hole with a 250mm diameter tapering down to 350mm diameter and 450mm depth

4

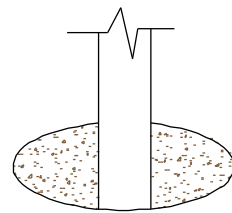

Compact base of hole with 50mm of aggregate. Lower ground Fix post attached of instrument into hole (check instrument straight and level before filling with concrete)

5

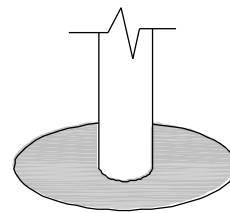

Fill hole with fast drying concrete to manufacturers specifications.

Duplicate points 1-5. Grand Marimba requires 4 Ground Fix Posts

Foundations should not present a hazard. These foundations are recommended as a guide, for more information on foundation details for various surface see Part 1 of BS EN 1176.

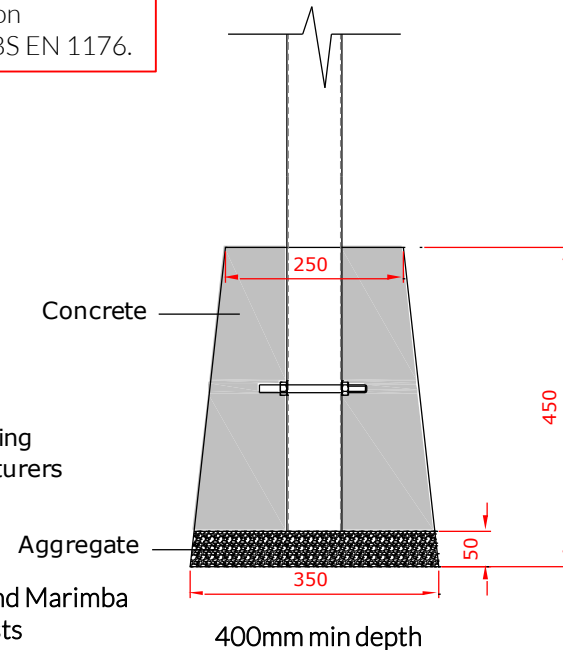

400mm min depth

Ground Fixed  
Grand Marimba  
Page 3 of 3



Components:

x4  
M10x200 Bolt

x8  
M10 Nut

Metric Conversion:  
50mm/ 2"  
250mm/ 10"  
350mm/ 14"  
400mm/ 16"  
450mm/ 18"

Thread Lock Solution  
Required (Not Supplied)