

Installation Instructions



1. Attach the steel legs to the base of the instrument with the M8 Nyloc Nuts and 2 part security caps. (1.1) (See Assembly Guide)

2. Attach Ground Fixing posts to legs (1.2) (See Ground Fix Post Installation Sheet)

3. Excavate 1 hole for the Steel legs 250mm diameter by 600-750mm deep depending on Key stage, in desired location upon decision from customer.

4. Locate (lower) leg into holes making sure they are vertical and level prior to concreting in place.

5. Once happy with location of the Instrument, fill holes using rapid hardening concrete. Be sure to compact concrete around legs and leave to dry according to manufactures guidelines.

6. Attach the 1 pair of beater to the saddle strap on the leg. (1.3)

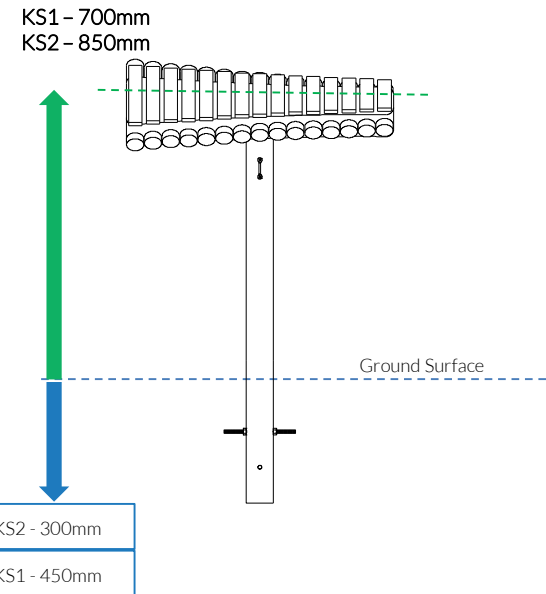
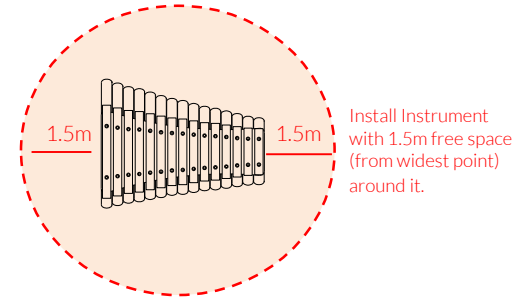

Weight of heaviest part 15kg (Cavatina) SD
Weight of heaviest part 23kg (Cavatina) HD

Ground Fixed

Cavatina
Page 1 of 3



Instrument Components:





-  x4
M8 Nyloc Nut
-  x2
M6x20 Security Screw
-  x4
2 Part Cover Cap
-  x1
M6 Saddle Strap

Metric Conversion:
250mm/ 10"
300mm/ 12"
450mm/ 18"
700mm/ 28"
850mm/ 33"
1.5m/ 59"



Pair Small Red Beaters X1



Ground Fix Components:

-  x2
M10x200 Bolt
-  x4
M10 Nut
-  x1
M10 Barrel Nut
-  x1
M10x70 Security Screw

Spares available from percussionplay.com or from your local distributor

19.5 Kg

Tools:

 x1
  x1

Ground Fixed
Cavatina
Page 2 of 3







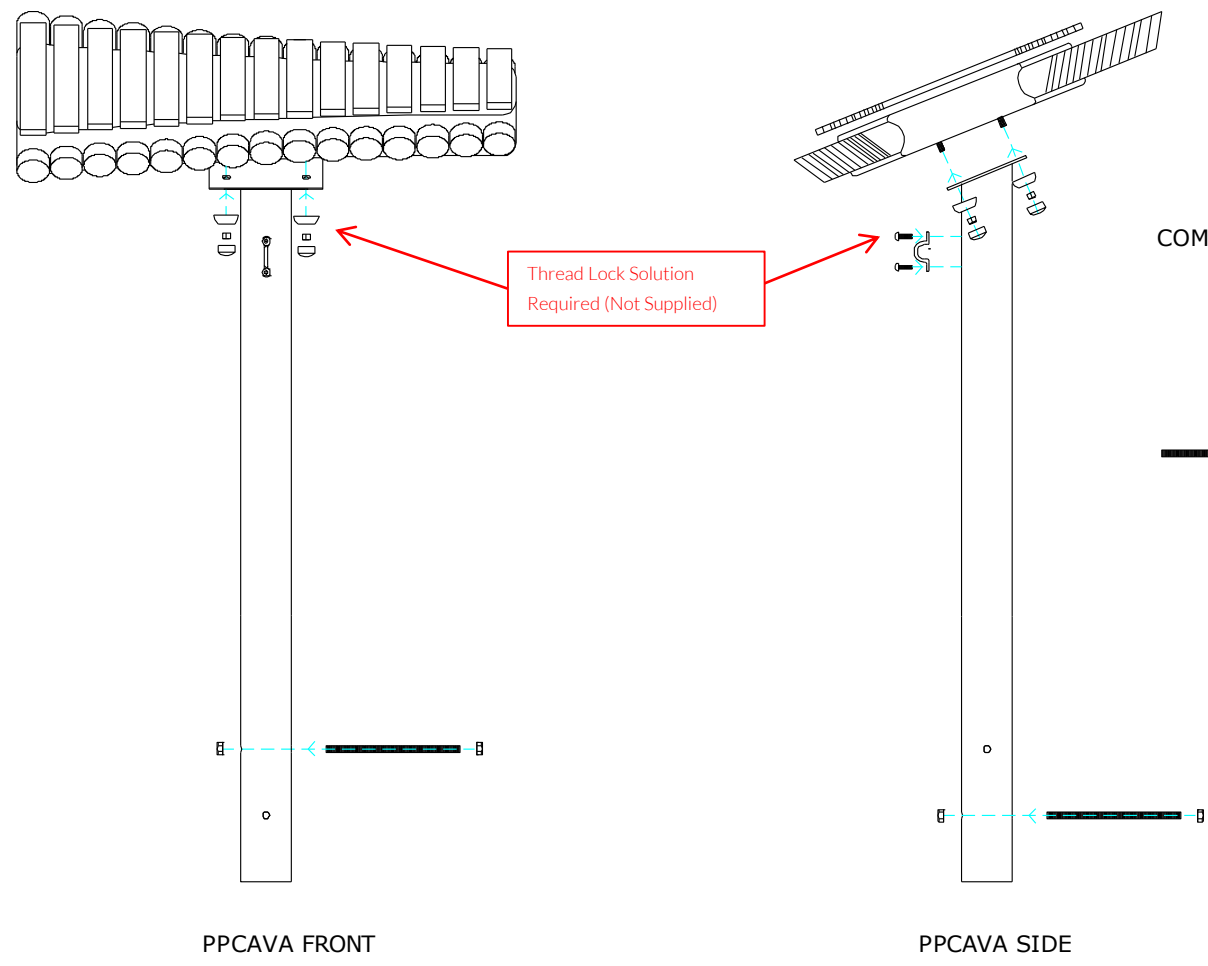

Instrument Components:

-  x4
M8 Nyloc Nut
-  x2
M6x20 Security Screw
-  x4
2 Part Cover Cap
-  x1
M6 Saddle Strap
- 

Thread Lock Solution Required (Not Supplied)







- COMPONENTS LIST:**
-  2 Part Cover Cap X4
 -  M8 Nyloc nut X4
 -  M10 Nut X4
 -  M10x200 Threaded Bar X2
 -  Saddle Strap X1
 -  M6x20 Pin torx X2



Pair Small Red Beaters X1

Ground Fix Components:

-  x2
M10x200 Bolt
-  x4
M10 Nut
-  x1
M10 Barrel Nut
-  x1
M10x70 Security Screw

Spares available from percussionplay.com or from your local distributor

19.5 Kg

Ground Fix Post Installation

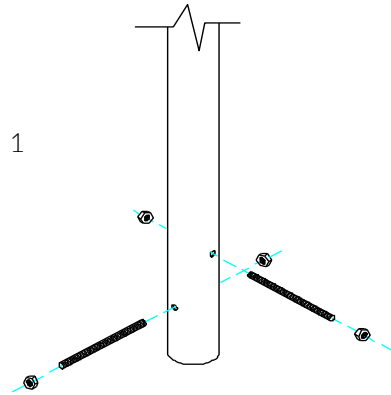

1
Insert M10x 200 Threaded bar into pre drilled holes in Ground Fixing Post

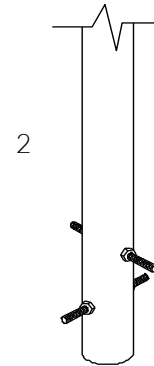

2
Fix M10x 200 Threaded bar in place using M10 Nuts

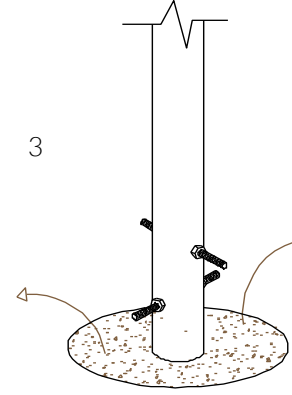

3
Excavate a hole with a 250mm diameter tapering down to 350mm diameter and 350mm depth

Foundations should not present a hazard. These foundations are recommended as a guide, for more information on foundation details for various surface see Part 1 of BS EN 1176.

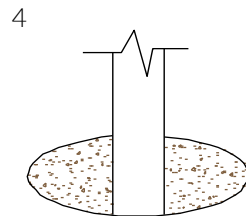

4
Compact base of hole with 50mm of aggregate. Lower ground Fix post attached of instrument into hole (check instrument straight and level before filling with concrete)

300mm min depth

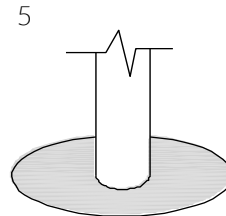

5
Fill hole with fast drying concrete to manufacturers specifications.

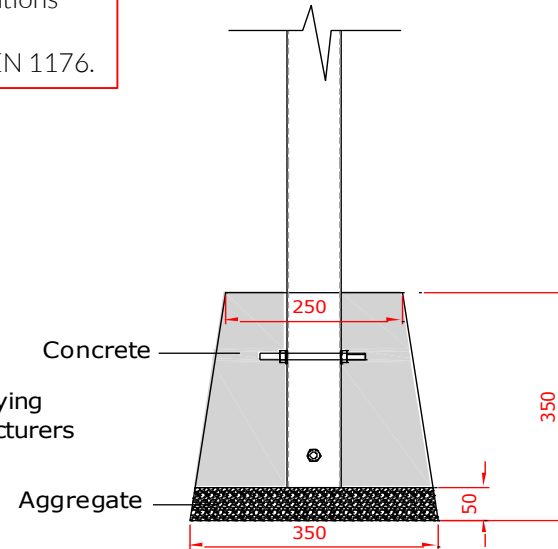

Ground Fixed

Cavatina
Page 3 of 3



Components:

 x2
M10x200 Bolt

 x4
M10 Nut

Metric Conversion:
50mm/ 2"
250mm/ 10"
300mm/ 12"
350mm/ 14"
400mm/ 16"
450mm/ 18"