

# Installation Instructions

## Ground Fixed

Liberty Bells  
Page 1 of 4



Weight of heaviest part **8Kg** (Large Bell)

**1.** Lay packaging out on floor and clear workspace with non-abrasive surface for assembly to prevent marking of polished stainless steel.

**2.** Unpack Liberty Bell chimes. Remove the nylon nut and 15mm spacer to expose pre-threadlocked thread.

**3.** Align the first small chime grate with the dowels on the end of the smallest post. Screw C5 (Indigo) chime onto the smallest post, over chime grate.

**4.** Repeat in ascending order of post height, matching the bells in ascending order of size. The three small chime grates match with the three smaller bells, and the three larger match with the three largest bells.

**5.** Unpack ground fixing extensions. Cluster them together with M10 tapped holes facing outward and ground fixing holes aligned (See Page 3). Insert M10x200mm threaded bars into ground fixing holes and secure loosely with M10 BZP nuts.

**6.** Sheath chime posts over ground fix stanchions in arrangement indicated, securing with M10x20mm security screws.

**7.** Excavate a hole for the frame **250mm diameter, tapering down to 350mm, 450 deep** in desired location upon decision from customer.

**8.** Fill bottom 50mm of hole with compressed aggregate.

**9.** Locate (lower) frame into hole making sure that the stems are straight and upright. **The M10 screw heads need to remain above ground for instrument maintenance.**

**10.** Once happy with location of the instrument, **fill hole using rapid hardening concrete.** Be sure to compact concrete around legs and leave to dry according to manufactures guidelines.

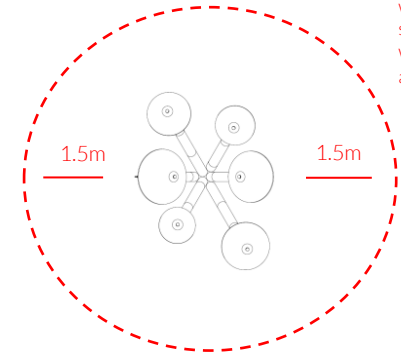

Install Instrument with 1.5m free space (from widest point) around it.

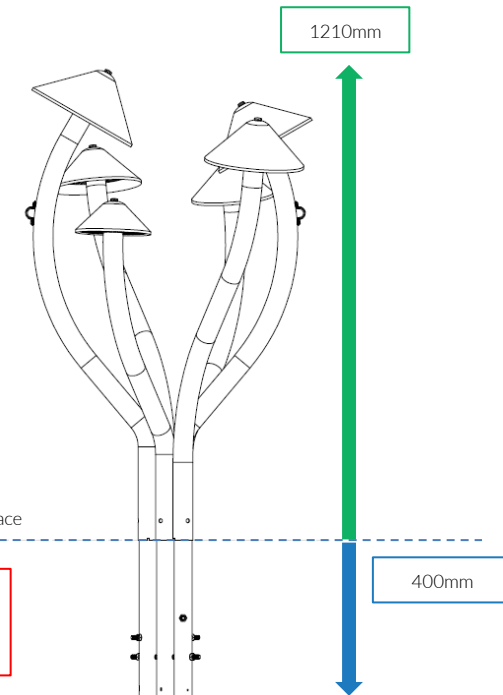

**CAUTION:** Frame surface can get hot in direct sunlight, if possible install in shaded areas.



Small Beaters X4

Ground Fix Components:



x3  
M10x200 Threaded bar



x6  
M10 BZP Nut



Spares available from  
[percussionplay.com](http://percussionplay.com) or from your local distributor

35 Kg

Metric Conversion:  
400mm/ 16"  
1200mm/ 47 16/25"  
1.5m/ 59"

## Bell Assembly

### Ground Fixed

Liberty Bells  
Page 2 of 4



1. Align chime grate with dowels and place on end of post. Ensure you have matched the correct grate size to the post (the larger match with the three larger posts and bells).

2. Select matching bell to secure onto the post. Align and gently begin to fasten clockwise.

3. With comfortable alignment, continue to rotate bell down onto post until fastened securely. Pre-applied threadlocker on the end of the bell's screw will prevent the bell from unfastening.

4. Lastly, tighten pan-head screw on top of bell gently with spanner (16mm or 5/8inches).

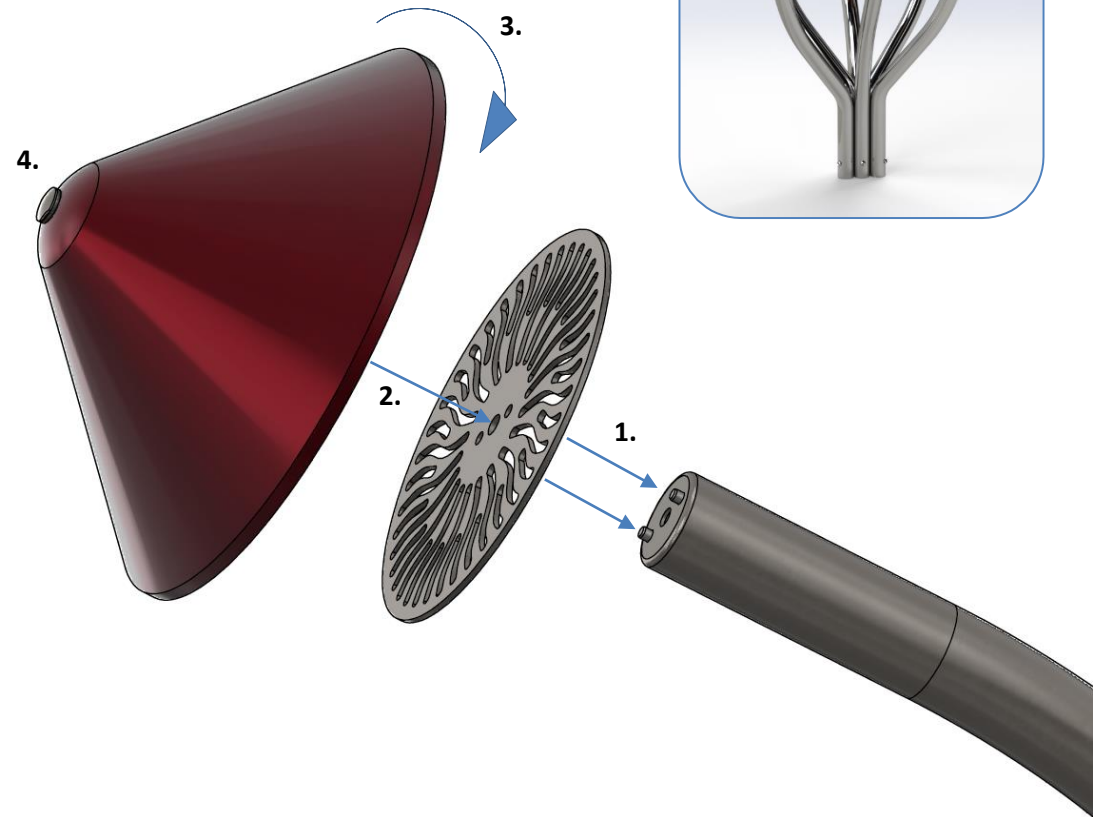

Small  
Beaters X4



# Ground Fix Installation

Tools:



x1  
TX 45 Driver Bit

## Ground Fixed

Liberty Bells  
Page 3 of 4



### Components:



Metric Conversion:  
50mm/ 2"  
250mm/ 10"  
400mm/ 16"  
450mm/ 18"

1.

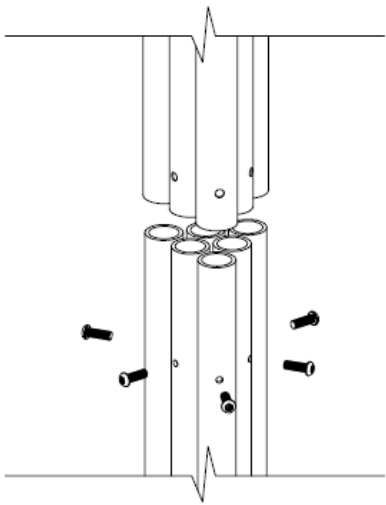

2.

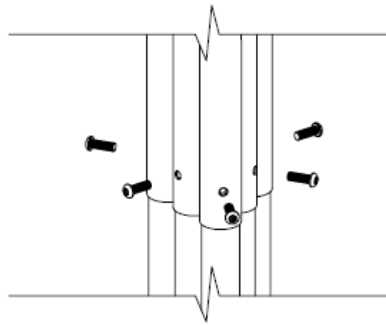

3.

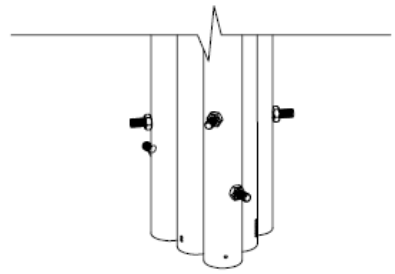
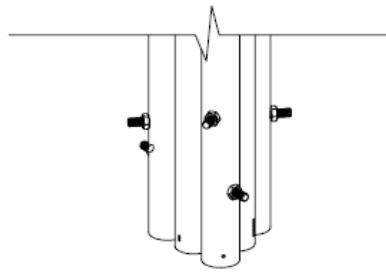
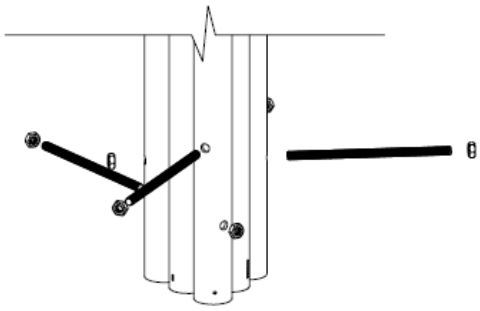
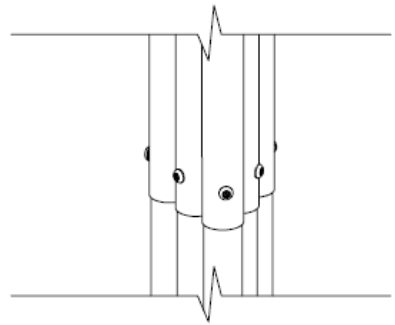

Small Beaters X4

Ground Fix Components:



x3  
M10x200 Threaded bar



x6  
M10 Nut



Spares available from  
[percussionplay.com](http://percussionplay.com) or from your  
local distributor

35 Kg

# Ground Fix Installation

1. Excavate a holes with a 250mm diameter tapering down to 350mm diameter and 450mm depth.

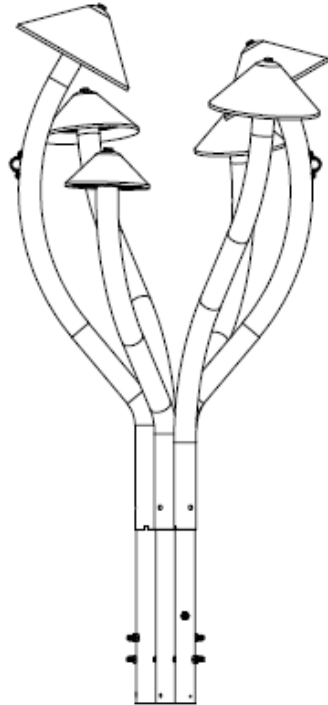

2. Compact base of hole with 50mm of aggregate. Lower ground fix duster attached to instrument into hole (check instrument straight and level before filling with concrete), ensuring 50mm of clearance between the ground and the bolt & barrel nut holes.

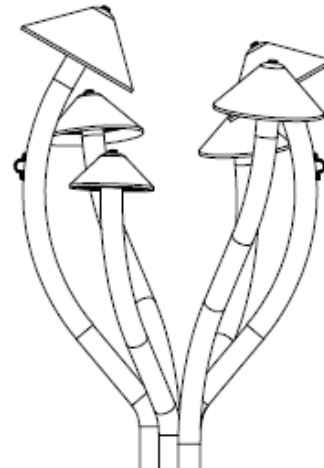

3. Fill hole with fast drying concrete to manufacturers specifications.

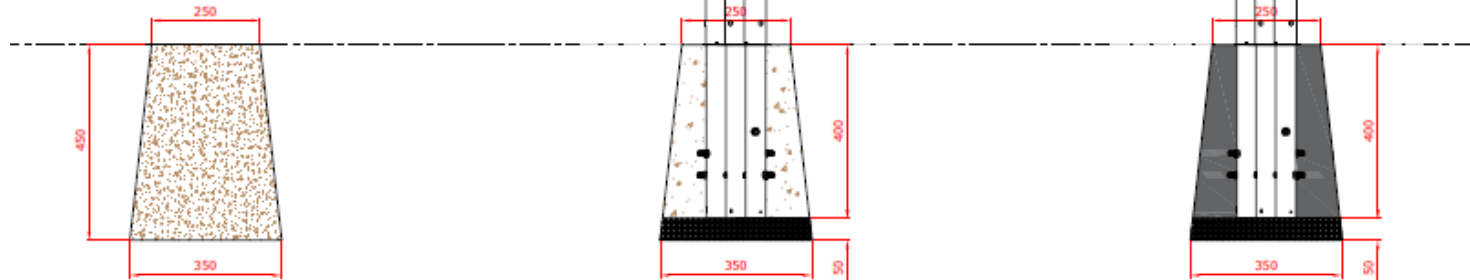
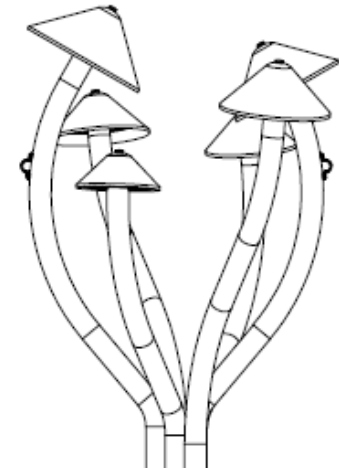

Foundations should not present a hazard. These foundations are recommended as a guide, for more information on foundation details for various surface see Part 1 of BS EN 1176.



## Ground Fixed

Liberty Bells  
Page 4 of 4



### Components:



x3

M10x200 Threaded Bar



x6

M10 BZP Nut

### Metric Conversion:

50mm/ 2"  
250mm/ 10"  
350mm/ 14"  
400mm/ 16"  
450mm/ 18"